

# comfee'

## Front Loading Washing Machine

Instruction Manual

CFP01EW90W

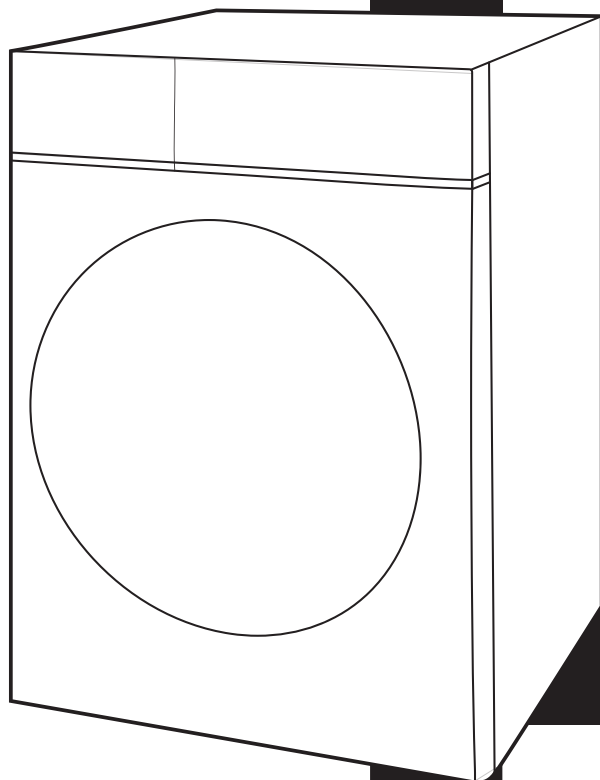

Read This Manual: Read all instructions and explanations for the installation before use. Follow the instructions carefully. Keep the operation instructions handy for later use.

If the appliance is sold or passed on, ensure that the new owner always receives this operation instructions.

# CONTENTS

---

## SAFETY INSTRUCTIONS

- Safety Instructions ..... 2

## INSTALLATION

- Product Description ..... 9
- Installation ..... 10

## OPERATION

- Quick Start ..... 13
- Before Each Washing ..... 15
- Detergent Dispenser ..... 16
- Control Panel ..... 18
- Programmes ..... 19
- Option ..... 23

## MAINTENANCE

- Cleaning and Care ..... 26
- Trouble Shooting ..... 29
- Customer Service ..... 30
- Technical Specifications ..... 31
- Product Fiche ..... 32

# SAFETY INSTRUCTIONS

---

## ■ Safety Instructions

Please read the following safety information thoroughly and follow it strictly to minimize the risk of fire or explosion, electric shock and to prevent property damage, personal injury or loss of life. Failing to follow these instructions shall void any warranty.

This appliance is not intended for use by persons (including children) with reduced physical, sensory or mental capabilities, or lack of experience and knowledge, unless they have been given supervision or instruction concerning use of the appliance by a person responsible for their safety.

### Warning!

This combination of symbol and signal word indicates a potentially dangerous situation which may result in death or serious injuries unless it's avoided.

### Caution!

This combination of symbol and signal word indicates a potentially dangerous situation which may result in slight or minor injuries or damage to property and the environment.

### Note!

This combination of symbol and signal word indicates a potentially dangerous situation which may result in slight or minor injuries.

### Warning!

## ELECTRIC SHOCK HAZARD

- If the supply cord is damaged, it must be replaced by the manufacturer, its service agent or similarly qualified persons in order to avoid a hazard.
- If the machine is damaged, it must not be operated unless repaired by the manufacturer, its service agent or similarly qualified persons.

Risk of electric shock!

# SAFETY INSTRUCTIONS

---

- The appliance can be used by children aged from 8 years and above and persons with reduced physical, sensory or mental capabilities or lack of experience and knowledge if they have been given supervision or instruction concerning use of the appliance in a safe way and understand the hazards involved. Children shall not play with the appliance. Cleaning and user maintenance shall not be made by children without supervision.
- Children should be supervised that they do not play with the appliance.
- Children 3 years and under shall be kept away from the appliance or continuously supervised.
- Animals and children may climb into the machine. Check the machine before every operation.
- Do not climb or sit on the appliance.

## INSTALLATION LOCATION AND SURROUNDING

- All washing and additional substances are to be kept in a safe place out of the reach of children.
- Do not install the machine on a carpet floor. The obstruction of the openings by a carpet can damage the machine.
- Keep the appliance clear from heating sources and direct sunlight to avoid plastic and rubber parts to corrode.
- Do not use the appliance in humid environments or rooms containing explosive or caustic gas. In case of water leakage or water splashes let the appliance dry in the open air.
- The appliance must not be installed behind a lockable door, a sliding door or a door with a hinge on the opposite side to that of the washer.

# SAFETY INSTRUCTIONS

---

- Do not operate the machine in rooms with a temperature of below 5°C. This can cause damages to parts of it. If it is unavoidable, make sure to drain the water completely from the appliance after every use (see „Maintenance - Cleaning of drain pump filter“) to avoid damages caused by frost.
- Never use flammable sprays or substances in the immediate proximity of the appliance.

## INSTALLATION

- Remove all packaging material and transport bolts before using the appliance. Otherwise, serious damage may result.
- This appliance is equipped with a single inlet valve and can be connected to the cold water supply only.
- Mains plug must be accessible after installation.
- Before washing clothes for the first time, the product shall be operated once throughout all the procedures without any clothes inside.
- Before using the washer, the product shall be calibrated.
- Do not put any excessively heavy objects on the appliance, like water containers or heating devices.
- The new hose-sets supplied with the appliance are to be used and that old hose-sets should not be reused.
- Max. Inlet water pressure 1 MPa. Min. inlet water pressure 0.05 MPa.

## ELECTRICAL CONNECTION

- Make sure the supply cable is not trapped by the machine, it can get damaged.
- Connect the product to a grounded outlet protected by a fuse complying with the values in the “ Technical specifications “ table. The grounding installation has to be made by a qualified electrician. Ensure that the machine is installed in accordance with the local regulations.

# SAFETY INSTRUCTIONS

---

•Water and electrical connections must be carried out by a qualified technician in accordance with the manufacturer's instructions and local safety regulations.

## Warning!

- Don't use multiple plugs or extension cords.
- The appliance must not have an external switching device such as a timer or connected to a circuit that is regularly switched on and off.
- Do not pull the plug out of the mains outlet if there is flammable gas around.
- Never pull out power plug with wet hands.
- Always pull at the plug, not at the cable.
- Always unplug the appliance if it is not being used.

## WATER CONNECTIONS

- Check the connections of the water inlet tubes, the water tap and the outlet hose for possible problems due to changes of water pressure. If the connections loosen or leak close the water tap and get it repaired. Do not use the appliance before the pipes and hoses are installed properly by qualified persons.
- Glass door may become very hot during the operation. Keep children and pets far away from the machine while it is operating.
- The water inlet and outlet hoses have to be safely installed and remain undamaged. Otherwise, water leakage can occur.
- Do not remove the drain pump filter while there is still water in the appliance. Big quantities of water can leak out, and there is a risk of scalding due to hot water.

# SAFETY INSTRUCTIONS

---

## OPERATION AND MAINTENANCE

- Never use any flammable, explosive or toxic solvents. Do not use gasoline and alcohol etc. as detergents. Only select detergents that are suitable for machine washing.
- Make sure that all pockets are emptied. Sharp and rigid items such as coins, brooches, nails, screws, stones etc. may cause serious damages to this machine.
- Remove all objects from pockets such as lighters and matches before use the appliance.
- Thoroughly rinse items that have been washed by hand.
- Items that have been soiled with substances such as cooking oil, acetone, alcohol, petrol, kerosene, spot removers, turpentine, wax and wax removers should be washed in hot with an extra amount of detergent before being dried in the appliance.
- Items containing foam rubber (latex foam), shower caps, water proof textiles, rubber backed articles and clothes or pillows fitted with foam rubber pads should not be dried in the machine
- Fabric softeners or similar products should be used as recommended in their instructions.
- Never try to open the door forcefully. The door will unlock shortly after the end of a cycle.
- Please do not close the door with excessive force. If it is found difficult to close the door, please check if the clothes are properly inserted and distributed.

# SAFETY INSTRUCTIONS

---

- Always unplug the appliance and close the water tap before cleaning and maintenance and after each use.
- Never pour water over the appliance for cleaning purpose. Risk of electric shock!
- Repairs shall only be carried out by the manufacturer, its service agent or similarly qualified persons in order to avoid a hazard. The producer will not be responsible for damages caused by the intervention of not authorized persons.

## TRANSPORT

- Before Transport:
  - Bolts shall be reinstalled to the machine by a specialized person
  - Accumulated water shall be drained out of the machine
- This appliance is heavy. Transport with care. Never hold any protruding part of the machine when lifting. The machine door cannot be used as a handle.

## INTENDED USE

The product is intended only for home use and for textiles in household amounts suitable for machine washing and drying. This appliance is for indoor use only and not intended for built in use. Only use according to these instructions. The appliance is not intended for commercial use.

Any other use is considered as improper use. The producer is not responsible for any damage or injuries that may result of it.

- This appliance is intended to be used in household and similar applications such as:
  - Staff kitchen areas in shops, offices and other working environments;
  - Farm houses;
  - By clients in hotels, motels and other residential type environments;
  - Bed and breakfast type environments;
  - Areas for communal use in blocks of flats or in launderettes.

# SAFETY INSTRUCTIONS

---

## Packaging/Old appliance



This marking indicates that this product should not be disposed with other household wastes throughout the EU. To prevent possible harm to the environment or human health from uncontrolled waste disposal, recycle it responsibly to promote the sustainable reuse of material resources. To return your used device, please use the collection systems or contact the retailer where the product was purchased. They return and can take this product for environmental safe recycling.

Model	Washing Capacity
CFP01EW90W	9.0kg

---

# INSTALLATION

## ■ Product Description

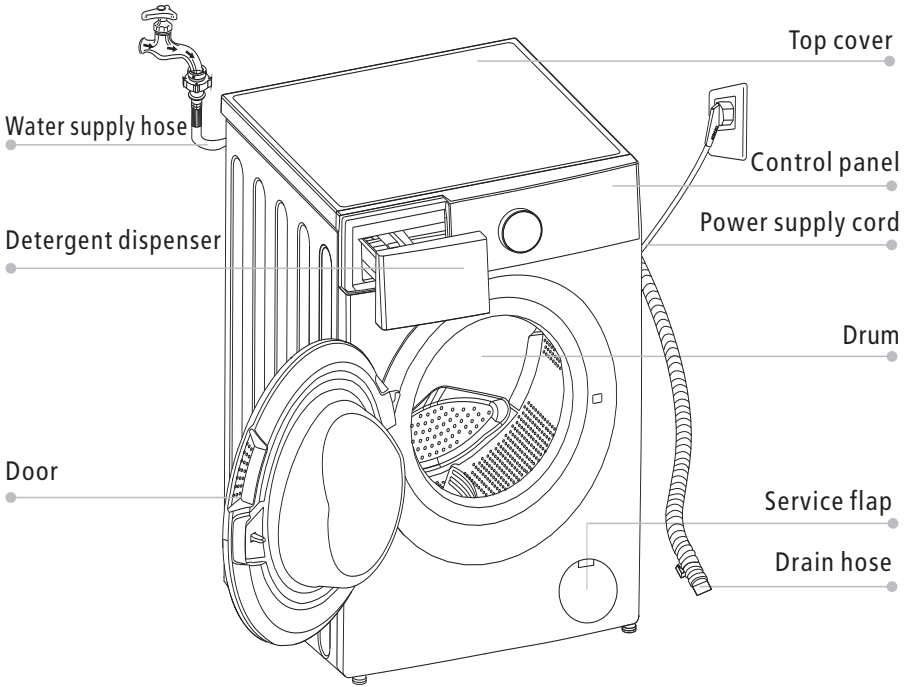

### Note!

- The product picture is for illustration only, please refer to real product as reference.

## Accessories

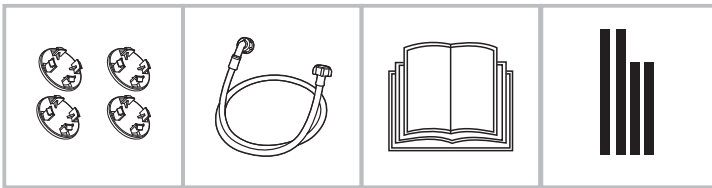

4 x Cover caps

1 x Supply hose  
cold water

1 x Owner's manual

Acoustic  
sponge  
(Optional)

# INSTALLATION

## ■ Installation

### Installation area

#### ⚠ Warning!

- Stability is important to prevent the product from wandering! Make sure the machine is standing leveled and stable.
- Make sure that the product does not stand onto the power cord.
- Make sure to maintain the minimum distances from the walls as shown in the picture

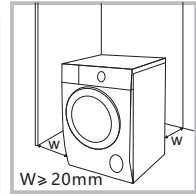

Before installing the machine, the location characterized as follows shall be selected:

1. Rigid, dry, and level surface
2. Avoid direct sunlight
3. Sufficient ventilation
4. Room temperature is above 5°C
5. Keep far away from the heat sources such as coal or gas burning appliances.

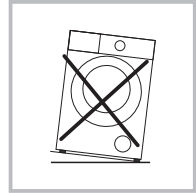

### Unpacking the washing machine

#### ⚠ Warning!

- Packaging material (e.g. Films, Styrofoam) can be dangerous for children.
- There is a risk of suffocation ! Keep all packaging well away from children.

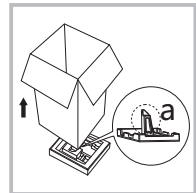

1. Remove the cardboard box and styrofoam packing.
2. Lift the washer and remove the base packaging. Make sure the small triangle foam (a) is removed with the bottom packaging together. If not, lay the unit down on the side surface and remove it manually.
3. Remove the tape securing the power supply cord and drain hose.
4. Remove the inlet hose from the drum.

# INSTALLATION

## Remove transport bolts

### ⚠ Warning!

- You must remove the transport bolts from the backside before using the product.



Loosen the 4 transport bolts with a spanner.

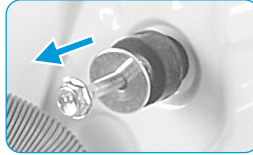

Remove the bolts including the rubber parts and keep them for future use.

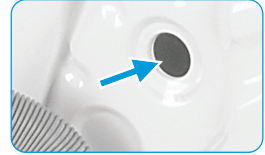

Close the holes using the cover caps.

## Levelling the washing machine

### ⚠ Warning!

- The lock nuts on all four feet must be screwed tightly against the housing.

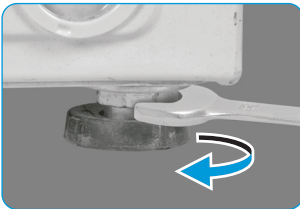

1. Loosen the lock nut.
2. Turn the foot until it reaches the floor.
3. Adjust the legs and lock the nuts with a spanner. Make sure the machine is level and steady.

## Connect the water supply hose

### ⚠ Warning!

To prevent leakage or water damage, follow the instructions in this chapter

- Do not kink, crush or modify water inlet hose.



Connect the water supply hose to the water inlet valve and a water tap with cold water as indicated.



### 🔧 Note!

- Connect manually, do not use tools. Check if the connections are tight.

# INSTALLATION

## Drain Hose

### ⚠ Warning!

- Do not kink or protract the drain hose.
- Position drain hose properly ,otherwise damage might result of water leakage.

There are two ways to place the end of drain hose:

1.Put it into the water trough.

2. Connect it to the branch drain pipe of the trough.

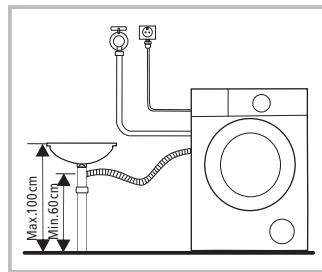
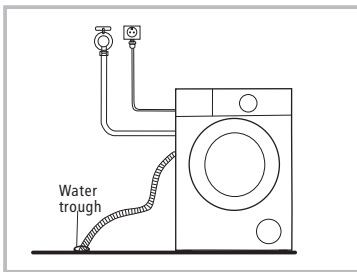

## Acoustic Sponge

### 📌 Note!

- Please make sure to assemble the acoustic sponges, which can effectively reduce the noise caused by the machine while working, in order to provide you with a more peaceful and quiet living environment.

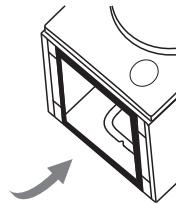
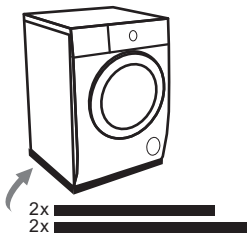

1. Get the machine laid on the floor, using some soft material like foam or clothes between the machine and floor for a protection;
2. Stick the 2x longer sponges to the longer bottom edges of machine, and the 2x shorter sponges to the shorter bottom edges.

# OPERATION

---

## ■ Quick Start

### ⚠ Caution!

- Before washing, please make sure the washer is installed properly.
- Your appliance was thoroughly checked before it left the factory. To remove any residual water and to neutralize potential odors, it's recommended to clean your appliance before first use. For this reason, recommended to clean the inner drum by running the "Drum Clean" or other program with the optional temperature of 90 °C. Be careful not to put laundry and detergent in the machine.

### 🔧 Calibration

It's recommended to calibrate the washing machine, so that provide the best performance.

The appliance is able to detect the amount of laundry loaded. This function is optimizing the product performance by minimizing energy and water consumption, saving you money and time. For this reason it's recommended to calibrate the appliance for best use.

- 1- Remove all accessories from the drum and close the door;
- 2- Insert the mains plug to the socket;
- 3- Switch on the washing machine and within 10 seconds, press "Speed" continuously (normally 3 seconds) until "t19" is displayed;
- 4- Press [▶||] to start the appliance and wait till "\*\*\*\*\*" is displayed.

# OPERATION

## 1. Before Washing

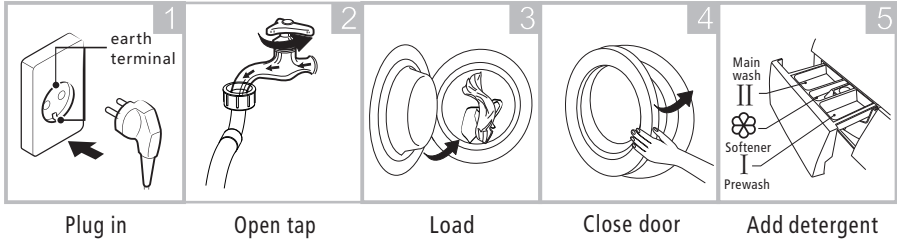

### Note!

- Detergent need to be added in compartment I if the pre-wash function is selected.

## 2. Washing

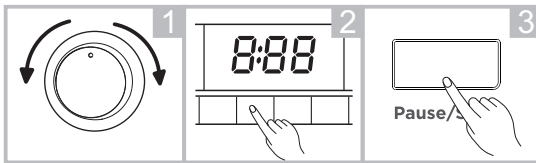

Select programme    Select function or remain default settings    Press Start/Pause to start the program

## 3. After Washing

Buzzer beep and "End" on display.

# OPERATION

## ■ Before Each Washing

- The ambient temperature of the washer should be 5-40°C. If used under 0°C, the inlet valve and draining system may be damaged. If the machine is installed under freezing conditions, it should be transferred to normal ambient temperature to ensure the water supply hose and drain hose can unfreeze before use.
- Please check your laundry care labels and the detergent use instructions before wash. Use non-foaming or less-foaming detergent suitable for machine washing properly.

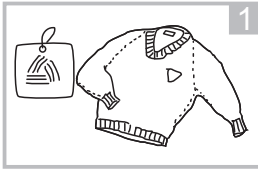

Check the care label

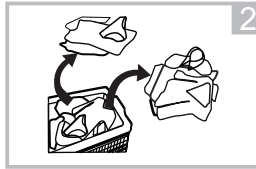

Sort laundry according to color and textile type



Take all items out of the pockets

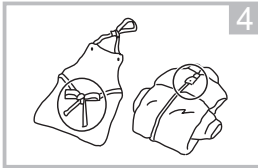

Tie together long textile strips and belts, close zips and button

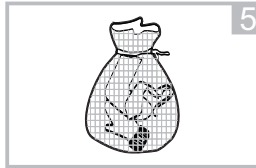

Put small items into a laundry bag

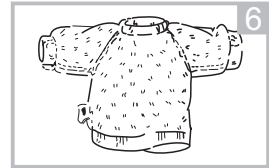

Turn easy-pilling and long-pile fabric inside out

### ⚠ Warning!

- Do not wash articles that have been cleaned in, washed in, soaked in, or dabbed with combustible or explosive substances like wax, oil, paint, gasoline, alcohol, kerosene, and other flammable materials.
- Washing single clothes items may easily create big eccentricity and cause alarm due to unbalance. Therefore it is suggested to add one or two more laundry items to the wash so that spin can be done smoothly.
- Do not wash, or spin water-proof seats, mats, or clothing.

# OPERATION

## ■ Detergent Dispenser

- I Pre wash
- II Main wash
- ☼ Softener
- ⊖ Release button to pull out the dispenser

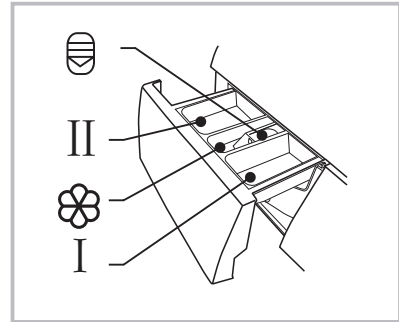

### ⚠ Caution!

- Detergent only need to be added in "compartment I "after selecting pre-wash function.

Programme	I	II	☼	Programme	I	II	☼
Quick 15'		●	○	Cotton(Cold)	○	●	○
Rapid 45'	○	●	○	Cotton (20°C)	○	●	○
Mix( 20°C)	○	●	○	Cotton (40°C)	○	●	○
Mix( 40°C)	○	●	○	Cotton( 60°C)	○	●	○
Mix( 60°C)	○	●	○	Jeans	○	●	○
Steam Wash	○	●	○	Delicate		●	○
Rinse&Spin			○	ECO 40-60		●	○
Spin Only							

● Means must      ○ Means optional

# OPERATION

---

## Detergent Recommendation

Recommended washing detergent	Wash cycles	Washing temp.	Type of laundry and textile
Heavy-duty detergent with bleaching agents and optical brighteners	Cotton,ECO 40-60	20/40/60	White laundry made from boil-proof cotton or linen
Colour detergent without bleaching agent and optical brighteners	Cotton,ECO 40-60	20/40/60	Coloured laundry made from cotton or linen
Color or mild detergent without optical brighteners	Delicate , Mix	20/30/40	Coloured laundry made from easy care fibres or synthetic materials
Mild washing detergent	Delicate	30	Delicate textiles, silk, viscose

### Note!

- Agglomerating or ropy detergent or additive can be diluted in some water before pouring it into the detergent dispenser, to avoid its inlet to get blocked and thus cause a water overflow.
- Please choose the suitable type of detergent to get a maximum of washing performance and a minimum of water and energy consumption
- To achieve the best cleaning result a proper detergent dosing is important.
- Use a reduced detergent amount if the drum is not filled completely.
- Always adjust the amount of detergent to the water hardness, if your tap water is soft, use less detergent.
- Dose according to how dirty your laundry is, less dirty clothes require less detergent.
- Highly concentrated (compact detergent) requires particularly accurate dosing.

Following symptoms are a sign of detergent overdosing:

- heavy foam formation
- poor washing and rinsing result

Following symptoms are a sign of detergent underdosing:

- laundry turns grey
- built-up of limescale deposits on the drum, the heating element and/or the laundry

# OPERATION

## ■ Control Panel

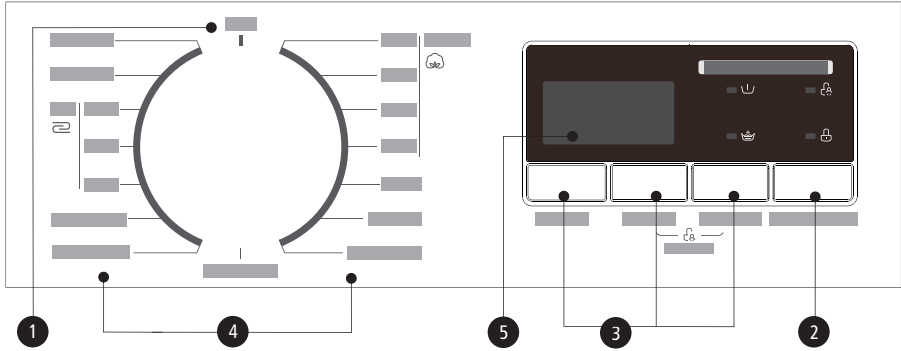

### 1 Off

Turn the appliance off.

### 2 Start/Pause

Start or pause your programme.

### 3 Option

This allows you to select additional functions.

### 4 Programmes

Available according to the laundry type.

### 5 Display

The display shows settings, estimated remaining time, options and status messages.

The diagram shows a close-up of the control panel. Callout A points to the display screen. Callout B points to the child lock button. Callout C points to the door lock button. Callout D points to the pre-wash button. Callout E points to the extra rinse button.

A Display	
Wash Time	Delay Time
1:25	2H
Speed	Error
400	E30
End	
End	

B Child Lock	C Door Lock
D Pre Wash	E Extra Rinse

# OPERATION

## ■ Programmes

Programme	Load(kg)	Temp.(°C)	Default Time
	9.0	Default	
Quick 15'	2.0	Cold	0:15
Rapid 45'	2.0	20	0:45
Mix( 20°C)	9.0	20	1:00
Mix( 40°C)	9.0	40	1:20
Mix( 60°C)	9.0	60	1:30
Steam Wash	4.5	40	1:48
Rinse&Spin	9.0	--	0:20
Spin Only	9.0	--	0:12
Cotton(Cold)	9.0	Cold	3:39
Cotton (20°C)	9.0	20	3:39
Cotton (40°C)	9.0	40	3:39
Cotton (60°C)	9.0	60	3:44
Jeans	9.0	30	1:35
Delicate	2.0	30	0:50
ECO 40-60	9.0	--	3:48



### Note!

- The parameters in this table are only for user's reference. The actual parameters maybe different with the parameters in above mentioned table.

# OPERATION

## ■ Programmes

CFP01EW90W							
Cycle	Nominal capacity in kg	Temperature setting	Cycle duration in h:min	Energy consumption in kWh/cycle	Water consumption in L/cycle	Highest washing temperature °C <sup>1)</sup>	Residual moisture in %/ Spin speed <sup>2)</sup>
Quick 15'	2.0	Cold	0:15	0.030	31	Cold	70%/800
Mix	9.0	40	1:20	0.813	78	40	65%/1000
Cotton (60°C)	9.0	60	3:44	1.500	78	60	53%/1400
Cotton (40°C)	9.0	40	3:39	0.953	78	40	65%/1000
Cotton (20°C)	9.0	20	3:39	1.380	78	20	65%/1000
ECO 40-60 <sup>3)</sup>	9.0	–	3:48	0.820	63.0	38	53.9%/1350
	4.5	–	2:54	0.475	49.0	30	53.9%/1350
	2.5	–	2:54	0.230	39.0	24	53.9%/1350

- The above data is for reference only, and the data may change due to different actual use conditions.
- The values given for programmes other than the ECO 40-60 programme are indicative only.
- 20 °C program is able to clean lightly soiled cotton laundry, at a nominal temperature of 20 °C, which complies with the regulation (EU) 2019/2023.
- Concerning to EN 60456:2016/A12:2023 With (EU)2019/2014, (EU)2019/2023, (EU)2021/340, (EU)2021/341

The EU energy efficiency class is: A

Energy test program: ECO 40-60. Other as the default.

Half load for 9.0kg machine:4.5kg.

Quarter load for 9.0kg machine:2.5kg.

# OPERATION

---

- 1) The highest temperature reached by the laundry in the wash cycle for at least 5 minutes.
- 2) Residual moisture after the wash cycle in water content percent and the spin speed at which this was achieved.
- 3) The ECO 40-60 programme is able to clean normally soiled cotton laundry declared to be washable at 40°C or 60°C, together in the same cycle. This programme is used to assess the compliance with the regulation (EU) 2019/2023.

The most efficient programmes in terms of energy consumption are generally those that perform at lower temperatures and longer duration.

Loading the household washer up to the capacity indicated for the respective programmes will contribute to energy and water savings.

Noise and remaining moisture content are influenced by the spinning speed: the higher the spinning speed in the spinning phase, the higher the noise and the lower the remaining moisture content.

## Caution!

- If there is any break in the power supply while the machine is operating, a special memory stores the selected programme. The machine will continue the programme when the power supply is re-established.

# OPERATION

---

## ■ Programmes

Programmes are available according to the laundry type.

Programmes	
Cotton	Hard-wearing textiles, heat-resistant textiles made of cotton or linen.
Steam Wash	The Steam Wash can deeply penetrate the fiber, which effectively eliminate bacterias and germs, preventing odors and protecting health.
Rapid 45'	Washing few and not very dirty clothes quickly.
Mix	Mixed load consisting of textiles made of cotton and synthetics.
Jeans	Specially for jeans.
Quick 15'	Extra short programme approx, suitable for lightly soiled washing as a small amounts of laundry.
Spin Only	Spins and drains the water.
Rinse&Spin	Rinses and then spins the laundry, and then drains the water.
ECO 40-60	Able to clean normally soiled cotton laundry declared to be washable at 40 °C or 60 °C, together in the same cycle.
Delicate	For delicate, washable textiles, e.g. made of silk, satin, synthetic fibres or blended fabrics.



### Note!

- Reference to your product to select the programmes.

# OPERATION

## ■ Option

Cycle	Default Temp.(°C)	Default spin speed in rpm	Additional functions
Wash cycles		1400	
Quick 15'	Cold	800	🕒
Rapid 45'	20	800	🕒, 📏, 👑
Mix( 20°C)	20	1000	🕒, 📏, 👑
Mix( 40°C)	40	1000	🕒, 📏, 👑
Mix( 60°C)	60	1000	🕒, 📏, 👑
Steam Wash	40	1000	🕒, 📏, 👑
Rinse&Spin	--	1000	🕒, 👑
Spin Only	--	1000	🕒
Cotton(Cold)	Cold	1400	🕒, 📏, 👑
Cotton (20°C)	20	1400	🕒, 📏, 👑
Cotton (40°C)	40	1400	🕒, 📏, 👑
Cotton( 60°C)	60	1400	🕒, 📏, 👑
Jeans	30	800	🕒, 📏, 👑
Delicate	30	800	🕒, 👑
ECO 40-60	--	--	🕒

### 📌 Note!

- For the maximum spin speed, program time, and other details of the ECO 40-60 program, please refer to the content on the Product Fiche page.
- The table shows which cycle offers which options for adjustment.

# OPERATION

---

Speed

## Speed

When needed, the spinning speed can be adjusted pressing the Speed button in the following steps: 1400: 0-400-600-800-1000-1200-1400

---

Delay

## Delay

1. Select a programme
2. Press the Delay button to choose the delaying time 0-24H
3. Press [Start/Pause] to start the delay operation



Choose programme



Setting time



Start

To cancel the Delay function, press the "Delay" button before starting the program until the display shows 0 H. If the program has already started, switch the appliance off and afterwards on and select a new programme.

---



## Pre Wash

Extra washing function before the main washing cycle starts to increase the washing performance.

Note: Detergent needs to be added to the compartment I.

---



## Extra Rinse

The laundry will undergo an extra rinse after selecting this function.

---

# OPERATION

---



## Child Lock

This function is meant to keep children from misusing the controls.

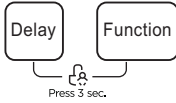

Press [Delay] and [Function] simultaneously for 3 sec until the buzzer beep. The child lock indicator switches on.

## ⚠ Caution!

When the Child Lock is activated, the display will alternately show "CL" and the remaining time.

Pressing any other button will cause the Child Lock indicator to flash.

When the program ends, "CL" and "End" will alternate on the display.

The Child Lock deactivates the function of all buttons except the Child lock button!

Only the simultaneous pressing of the two buttons can deactivate the Child Lock!

Please deactivate the Child Lock before selecting a new program!

## 📌 Note!

Usage counter

1. Unplug the equipment for 10s and reconnect again.
2. Power on and within 10s, please press "Speed" and "Function" on control panel simultaneously and continuously for around 5s until the device display shows digits--the value can indicate the times of equipment usage.
3. Repeat step 1 again and customer can resume to normal operation.

# MAINTENANCE

---

## ■ Cleaning and Care

### ⚠ Warning!

- Always unplug the appliance and close the water tap before cleaning and maintenance.

### Cleaning the Cabinet

Proper maintenance on the washing machine can extend its working life. The surface can be cleaned with diluted non-abrasive neutral detergents when necessary. If there is any water overflow, use a cloth to wipe it off immediately. Never use sharp items to clean the appliance.

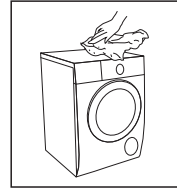

### ⚠ Caution!

- Never use abrasive or caustic agents, formic acids or its diluted solvents or similar substances, like alcohol or chemical products.

### Cleaning the Drum

Any rust stains left inside the drum by metal articles must be removed immediately using chlorine-free detergents. Never use steel wool for cleaning the drum!

### 📌 Note!

- Keep any laundry away from the machine while cleaning the drum.

### Cleaning the Door Seal and Glass

Wipe the glass and seal after each wash to remove lint and stains. If lint builds up it can cause leakages.

Remove any coins, buttons and other objects from the seal after each wash.

Clean the Door Seal and Glass every month to ensure the normal operation of the appliance.

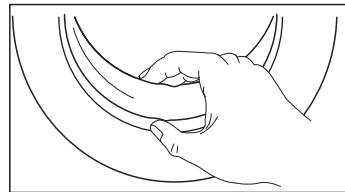

# MAINTENANCE

## Cleaning the Inlet Filter

### Note!

- Diminishing water flow is a sign that the filter need to be cleaned.

1. Close the tap and remove the water supply hose from it.
2. Clean the filter with a brush.
3. Unscrew the water supply hose from the backside of the machine. Pull out the filter with long nose pliers.
4. Use a brush to clean the filter.
5. Reinstall the filter to the water inlet and reconnect the water supply hose.
6. Clean the Inlet filter every 3 months to ensure the normal operation of the appliance.

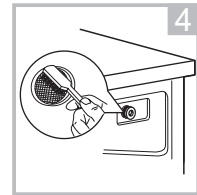
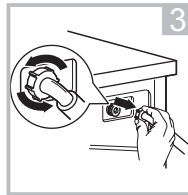
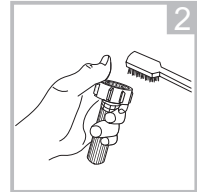
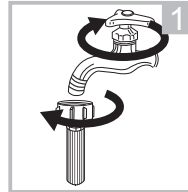

## Clean The Detergent Dispenser

1. Press down the release [  ] on the softener cover and pull the dispenser drawer out of the recess. Clean the inside of the recess with a brush.
2. Lift the softener cover off the dispenser drawer and wash both items with water.
3. Restore the softener cover and push the drawer back into the recess.

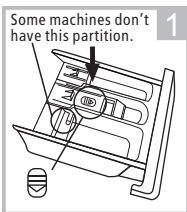

Press the release and remove the dispenser drawer

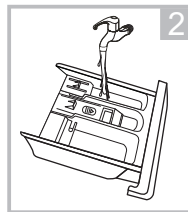

Clean the dispenser drawer and the softener cover under water

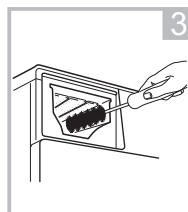

Clean the recess with an soft brush

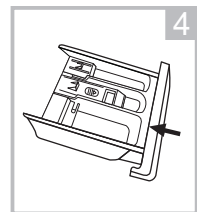

Insert the dispenser drawer

### Note!

- Do not use abrasive or caustic agents to clean plastic parts.
- Clean the detergent dispenser every 3 months to ensure the normal operation of the appliance.

# MAINTENANCE

## Cleaning the Drain Pump Filter

### ⚠ Warning!

- Make sure that the machine has finished the washing cycle and is empty. Switch it off and unplug it before cleaning the drain pump filter.
- Be careful of hot water. Allow the water to cool down. Risk of scalding!
- Clean the filter periodically every 3 months to ensure the normal operation of the appliance.

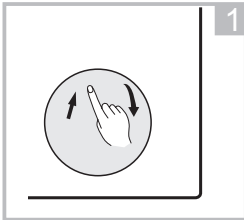

Open the lower cover cap

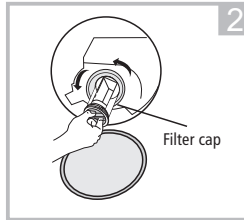

Open the filter by turning to the counter clockwise

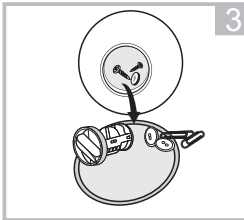

Remove extraneous matter

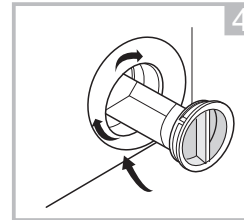

Close the lower cover cap

### ⚠ Caution!

- When the appliance is in use and depending on the programme selected there can be hot water in the pump. Never remove the pump cover during a wash cycle, always wait until the appliance has finished the cycle, and is empty. When replacing the cover, ensure it is securely re-tightened.

# MAINTENANCE

---

## ■ Trouble Shooting

Whenever there is a problem with the appliance, check if you can solve it following the tables below. If the problem persists, please contact the customer service.

Description	Possible cause	Solution
Appliance does not start	Door is not closed properly. Clothes are stuck.	Close the door properly and restart. Check the laundry.
Door can't be opened	Safety protection is activated.	Disconnect the power and restart.
Water leakage	Connections are not tight enough.	Check and fasten the water inlet pipe. Check and clean the outlet hose.
Detergent residues in the detergent dispenser	Detergent is damp and/or clotted.	Clean and wipe the detergent dispenser dry.
Indicator or display does not work	PC board or harness have connection problems.	Switch off the power and check if the mains plug is connected properly.
Abnormal noise	Fixing bolts still in place. Floor is not solid or level.	Check if the fixing bolts have been removed Make sure the appliance is installed on a solid and level floor.

## Error Codes

Description	Possible cause	Solution
<b>E30</b>	Door is not closed properly	Close the door properly and restart.
<b>E10</b>	Water injecting problem during wash cycle.	Check if the water pressure is high enough. Straighten the water pipe. Clean the inlet valve filter.
<b>E21</b>	Overtime water draining	Check the drain hose for blockage.
<b>E12</b>	Water overflow	Restart the appliance.
<b>EXX</b>	Others	Restart the appliance. If problem persists, please contact the customer service.

---

# MAINTENANCE

---

## ■ Customer Service

Spare part for your appliance are available for a minimum of 10 years.

In case of questions please contact our customer service at:



### Warning!

Risk of electric shock

- Never try repair an appliance which is defective or presumed to be defective. You may put your own and future users' lives in danger. Only authorised specialists are allowed to carry out this repair work.
- Improper repair will void the warranty and subsequent damages can't be recognized!

## Transport

### IMPORTANT STEPS WHEN MOVING THE APPLIANCE

- Unplug the appliance and close the water inlet tap.
- Check, if the door and the detergent dispenser are closed properly.
- Remove the water inlet pipe and the outlet hose from the house installations.
- Let the water drain completely from the appliance (see "Maintenance Cleaning the drain pump filter")
- Important: Re-install the 4 transport bolts in the back of the appliance.
- This appliance is heavy. Transport with care. Never hold any protruding part of the machine when lifting. The machine door cannot be used as a handle.

# MAINTENANCE

## ■ Technical Specifications

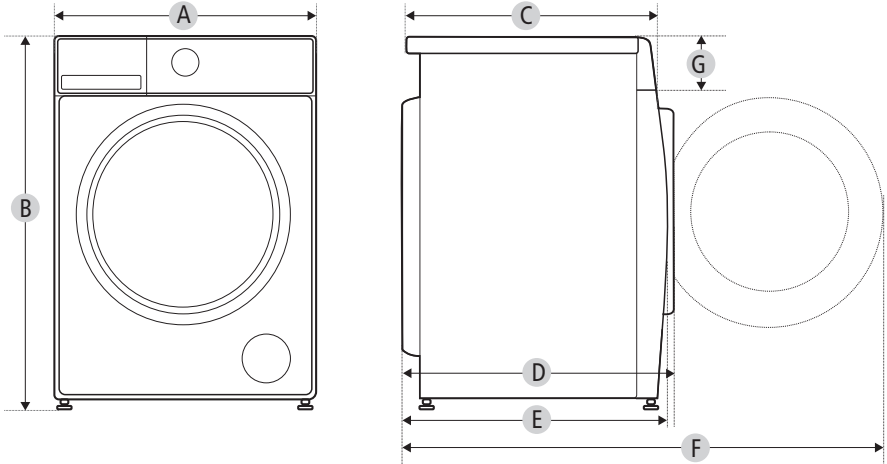

Model	CFP01EW90W
Power Supply	220-240V~,50Hz
MAX. Current	10A
Standard Water Pressure	0.05MPa~1MPa
Washing Capacity	9.0kg
Dimension	
A	595mm
B	850mm
C	495mm
Weight	60kg
Rated Power	1950W
Reference Dimension	
D	553mm
E	511mm
F	987mm
G	124mm

# MAINTENANCE

## ■ Product Fiche

Supplier's name or trade mark<sup>(a)</sup>(<sup>†</sup>):

Supplier's address<sup>(a)</sup>(<sup>†</sup>):

Model identifier<sup>(a)</sup>: CFP01EW90W

### General product parameters:

Parameter	Value	Parameter	Value	
Rated capacity <sup>(b)</sup> (kg)	9.0	Dimensions in cm <sup>(b)</sup> , ( <sup>†</sup> )	Height   85	
			Width   60	
			Depth   50	
Energy efficiency index <sup>(b)</sup> (EEI <sub>w</sub> )	51.9	Energy efficiency class <sup>(b)</sup>	A <sup>(d)</sup>	
Washing efficiency index <sup>(b)</sup>	1.031	Rinsing effectiveness (g/kg) <sup>(b)</sup>	5.0	
Energy consumption in kWh per cycle, based on the eco 40-60 programme at a combination of full and partial loads. Actual energy consumption will depend on how the appliance is used.	0.494	Water consumption in litre per cycle, based on the eco 40-60 programme at a combination of full and partial loads. Actual water consumption will depend on how the appliance is used and on the hardness of the water.	50	
Maximum temperature inside the treated textile <sup>(b)</sup> (°C)	Rated capacity	38	Weighted remaining moisture content <sup>(b)</sup> (%)	53.9
	Half	30		
	Quarter	24		
Spin speed <sup>(b)</sup> (rpm)	Rated capacity	1350	Spin-drying efficiency class <sup>(b)</sup>	B <sup>(d)</sup>
	Half	1350		
	Quarter	1350		
Programme duration <sup>(b)</sup> (h:min)	Rated capacity	3:48	Type	free-standing
	Half	2:54		
	Quarter	2:54		
Airborne acoustical noise emissions in the spinning phase <sup>(b)</sup> (dB(A) re 1 pW)	76	Airborne acoustical noise emission class <sup>(b)</sup> (spinning phase)	B <sup>(d)</sup>	
Off-mode (W) (if applicable)	0.50	Standby mode (W) (if applicable)	N/A	
Delay start (W) (if applicable)	4.00	Networked standby (W) (if applicable)	N/A	

Minimum duration of the guarantee offered by the supplier <sup>(a)</sup>(<sup>†</sup>):

This product has been designed to release silver ions during the washing cycle

NO

### Additional information:

Weblink to the supplier's website, where the information in point 9 of Annex II to Commission Regulation (EU) 2019/2023 <sup>(1)</sup> is found:

<sup>(a)</sup> this item shall not be considered relevant for the purposes of Article 2(6) of Regulation (EU) 2017/1369.

<sup>(b)</sup> for the eco 40-60 programme.

<sup>(c)</sup> changes to this item shall not be considered relevant for the purposes of paragraph 4 of Article 4 of Regulation (EU) 2017/1369.

<sup>(d)</sup> if the product database automatically generates the definitive content of this cell, the supplier shall not enter these data.

# MAINTENANCE

---

- 1) The actual energy consumption will depend on how the appliance is used.
- 2) The actual water consumption will depend on how the appliance is used and on the hardness of the water.
- 3) Delivery of the spare parts within 15 working days after having received the order.

## Product Data Sheet concerning (EU) 2019/2014

The product data sheet for your appliance can be found online.

Go to <https://eprel.ec.europa.eu> and enter the model identifier for your appliance to download the data sheet.

The model identifier for your appliance can be found in the technical specifications section.

# WARRANTY CARD

## NOTES

**We provide a guarantee for this machine in accordance with the following conditions: You have a manufacturer's warranty of \_\_\_\_\_ years from the date of purchase (proof of purchase must be provided). Our General Terms and Conditions apply.**

Your device / serial number

Purchase date:

Place of purchase:

Do you have any questions ?

We are happy to support you !

**Comfee'**  
*...is how I feel!*